



3 year guarantee - Made in France

Specific information

# MINDER TWIN

(EN) Pulley  
(FR) Poulie  
(DE) Seilrolle  
(IT) Carrucola  
(ES) Polea

**MINDER**



**295 g**



7 ≤ Ø ≤ 13 mm

**TWIN**



**450 g**

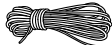

7 ≤ Ø ≤ 13 mm

CE 0082 EN12278

individually tested



P605010B (080410) recto

## NFPA CERTIFICATION FOR MINDER P60A and TWIN P65A



THIS MINDER / TWIN MEETS THE AUXILIARY EQUIPMENT REQUIREMENTS OF NFPA 1983, STANDARD ON LIFE SAFETY ROPE AND EQUIPMENT FOR EMERGENCY SERVICES, 2006 EDITION.

MBS 36 kN  
G (GENERAL USE)  
MEETS NFPA  
1983 (2006 ED.)



After removing the notice from the equipment, make a copy of it and keep the original as part of a permanent record that includes the usage and inspection history for the equipment. Keep the copy of the notice with the equipment and refer to it before and after each use. Additional information regarding auxiliary equipment can be found in NFPA 1500, Standard on Fire Department Occupational Safety and Health Program, and NFPA 1983, Standard on Fire Service Life Safety Rope and System Components.

### Tracability and Markings

MINDER	TWIN
	
<b>CE 0082</b>	
<b>a.</b> Body controlling the manufacture of this PPE	<b>b.</b> Notified body that carried out the CE type inspection
APAVE SUD Europe BP 193, 13322 Marseille Cedex 16 N°0082	
<b>c.</b> Traceability: datamatrix = product reference + individual number	
<b>e.</b> Individual number	
<b>00 000 A 0000</b>	
<b>f.</b> Year of manufacture	<b>g.</b> Day of manufacture
<b>h.</b> Control or name of inspector	<b>i.</b> Incrementation
<b>d.</b> Rope diameter	

### 1. Field of application

### 2. Nomenclature of parts

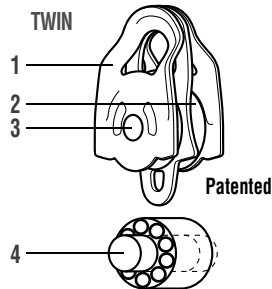
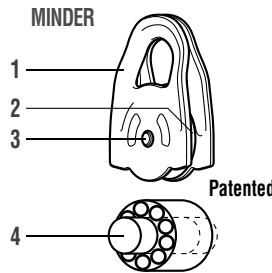

### 3. Inspection, points to verify

### 4. Compatibility

MINDER / TWIN

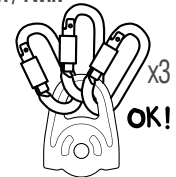

TWIN

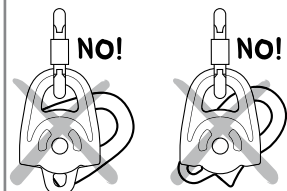

## 5. Values

5A. Working load limit  
Valeur d'utilisation maxi  
Maximale Gebrauchslast  
Valore d'utilizzo massimo  
Valor de utilización máximo

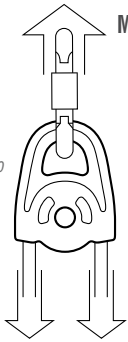

MINDER

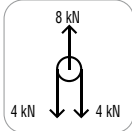

OK!

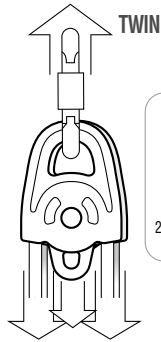

TWIN

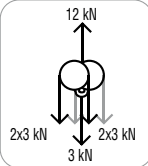

OK!

5B. Breaking load  
Charge de rupture  
Bruchlast  
Carico di rottura  
Carga de rotura

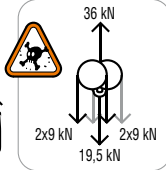
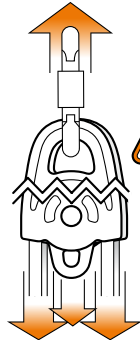
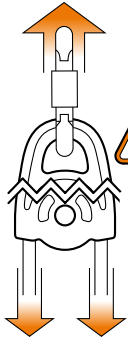

## 6. Pulley system efficiency

6A. Simple pulley system

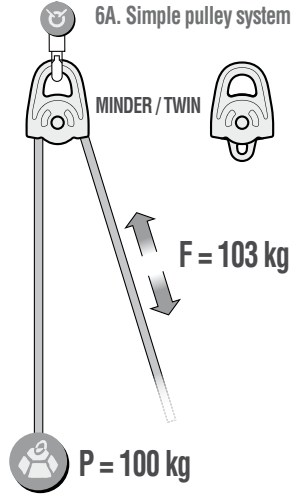

with progress capture

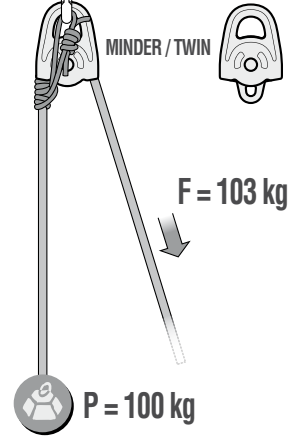

Theoretical force

$$F = P$$



$$F = 1,03 P$$



$$F = 2 P$$

6B. 2:1 hauling system

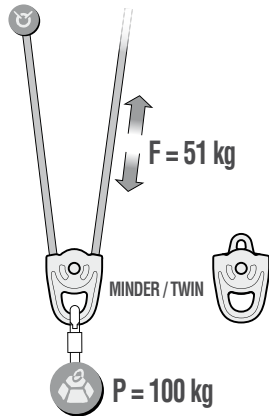

Theoretical force

$$F = 0,5 P$$



$$F = 0,51 P$$



$$F = 0,66 P$$

6C. 3:1 hauling system

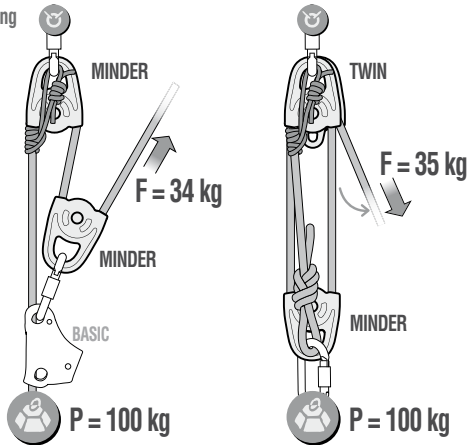

$$F = 0,33 P$$

$$F = 0,34 P$$

$$F = 0,35 P$$

$$F = 0,57 P$$

$$F = 0,875 P$$

6D. 4:1 hauling system with progress capture for double pulleys

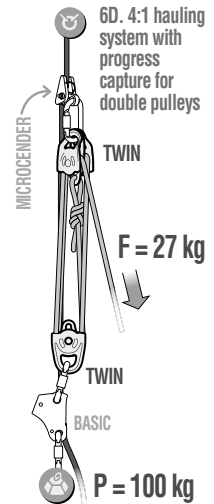

$$F = 0,25 P$$

$$F = 0,27 P$$

$$F = 0,937 P$$

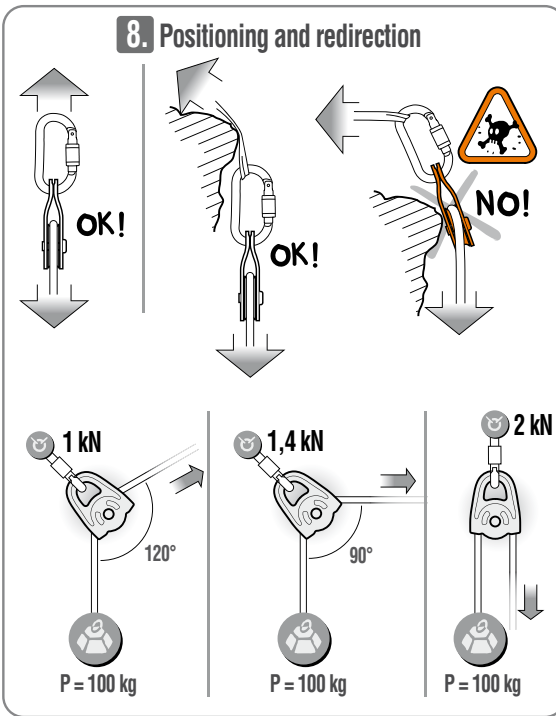
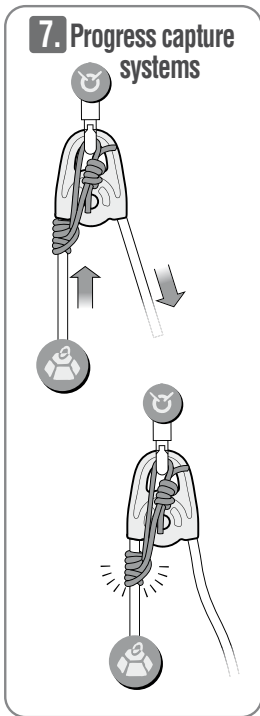

<p>             + 80°C            + 176°F              - 40°C            - 40°F         </p> <p>           (EN) Temperature            (FR) Température            (DE) Temperatur            (IT) Temperatura            (ES) Temperatura            (PT) Temperatura            (NL) Temperatuur            (SE) Temperatur            (FI) Lämpötila            (NO) Temperatur              (PL) Pakowanie i transport            (SI) Shranjevanje in transport            (HU) Tárolás, szállítás            (BG) Транспорти и съхранение            (JP) 持ち運びと保管方法            (KR) 보관과 운송            (CN) 运输及储存            (TH) การขนส่งและกการเก็บรักษา         </p>	<p>           (RU) Температура            (CZ) Teplota            (PL) Temperatura            (SI) Temperatura            (HU) Hőmérséklet            (BG) Температура            (JP) 気温            (CN) 温度            (TH) อุณหภูมิ         </p>	<p>             (EN) Cleaning Disinfection            (FR) Nettoyage Désinfection            (DE) Reinigung Desinfektion            (IT) Pulizia Disinfezione            (ES) Limpieza Desinfección            (PT) Limpeza Desinfeção            (NL) Reiniging Ontsmetting            (SE) Rengöring Desinficering            (FI) Puhdistus Desinfiointi            (NO) Rengjøring Desinfisering            (RU) Чистка Дезинфекция              (CZ) Čištění Desinfekce            (PL) Czyszczenie Dezynfekcja            (SI) Čiščenje/razkuževanje            (HU) Tisztítás            (BG) Почистване Дезинфекция            (JP) 手入れ方法 消毒            (KR) 손질            (CN) 清洗 消毒            (TH) ทำความสะอาดโดย ใช้สารฆ่าเชื้อ         </p>	<p>             (EN) Maintenance            (FR) Entretien            (DE) Wartung            (IT) Manutenzione            (ES) Mantenimiento            (PT) Manutenção            (NL) Onderhoud            (SE) Underhåll            (FI) Huolehtiminen            (NO) Vedlikehold              (RU) Техническое обслуживание            (CZ) Údržba            (PL) Konserwacja            (SI) Vzdrževanje            (HU) Karbantartás            (BG) Поддръжане            (JP) メンテナンス            (KR) 유지            (CN) 保养            (TH) การซ่อมแซม         </p>	<p>             (EN) Dangerous products            (FR) Produits dangereux            (DE) Gefährliche Produkte            (IT) Prodotti pericolosi            (ES) Productos peligrosos            (PT) produtos perigosos            (NL) Gevaarlijke producten            (SE) Farliga produkter            (FI) Vaaralliset tuotteet            (NO) Farlige produkter            (RU) Опасная продукция              (CZ) Nebezpečné výrobky            (PL) Produkty niebezpieczne            (SI) Nevarne kemikalije            (HU) Veszélyes termékek            (BG) Опасни продукти            (JP) 有害物質            (KR) 위험물            (CN) 危险品            (TH) วัตถุอันตราย         </p>
--	--	--	---	---

### Legends

	<p>           (EN) Anchor            (FR) Amarrage            (DE) Anschlagpunkt            (IT) Ancoraggio            (ES) Anclaje            (PT) Amarração            (NL) Verankering         </p>	<p>           (SE) Förankring            (FI) Ankkuri            (NO) Forankring            (RU) Точка страховки            (CZ) Ukotvení            (PL) Punkt stanowiskowy         </p>	<p>           (SI) Sidrišče            (HU) Fix pont            (BG) Закрепване            (JP) 支点            (KR) 확보점            (CN) 确定点            (TH) สัมผัส         </p>
--	--	---	--

PETZL  
 ZI Cidex 105A  
 38920 Crolles  
 France  
[www.petzl.com/contact](http://www.petzl.com/contact)

ISO 9001  
 Copyright Petzl